

# INTEX<sup>®</sup> OWNER'S MANUAL INFLATABLE KAYAK

## IMPORTANT

**THIS BOOKLET CONTAINS IMPORTANT SAFETY INFORMATION. READ IT THOROUGHLY BEFORE USING THIS PRODUCT AND KEEP IT FOR FUTURE REFERENCE.**

## ISO-6185 KAYAK

Due to a policy of continuous product improvement, Intex reserves the right to change specifications and appearance, which may result in updates to the instruction manual, without notice.

©2023 Intex Marketing Ltd. - Intex Development Co. Ltd. - Intex Recreation Corp. All rights reserved/Tous droits réservés/Todos los derechos reservados/Alle Rechte vorbehalten. Printed in China/Imprimé en Chine/Impreso en China/Gedruckt in China.  
®™ Trademarks used in some countries of the world under license from®™ Marques utilisées dans certains pays sous licence de/Marcas registradas utilizadas en algunos países del mundo bajo licencia de/Warenzeichen verwendet in einigen Ländern der Welt in Lizenz von/  
Intex Marketing Ltd. to/à/a/an Intex Development Co. Ltd., Hong Kong & Intex Recreation Corp., P.O. Box 1440, Long Beach, CA 90801 • Distributed in the European Union by/Distribué dans l'Union Européenne par/Distribuido en la unión Europea por/Vertrieb in der Europäischen Union durch/Intex Trading B.V., Ettenseweg 46, 4706 PB Roosendaal - The Netherlands • Distributed in the UK by Unitex Service (UK) Limited, 21 Holborn Viaduct, London EC1A 2DY, UK.  
[www.intexcorp.com](http://www.intexcorp.com)

**INTEX<sup>®</sup>**

084-\*A\*-R1-2410

**TABLE OF CONTENTS**

INTRODUCTION.....3

MANUFACTURER’S CERTIFICATION.....3

SAFETY & WARNING.....3

MANUFACTURER’S RECOMMENDATION.....4

DESCRIPTION.....5-6

SKEG INSTALLATION AND REMOVAL.....6

GOPRO OR SMARTPHONE MOUNT KIT INSTALLATION.....6

INFLATING INSTRUCTIONS .....7

FISHING ROD HOLDER USE.....7

SEAT INSTALLATION.....7

SEAT BOOSTER PAD INSTALLATION.....7

FOOTREST ASSEMBLY.....7

PADDLE ASSEMBLY.....8

SAFETY AND OPERATION INSTRUCTIONS.....8-9

CARE AND MAINTENANCE.....9

DISASSEMBLY AND STORAGE.....10

TROUBLESHOOTING.....10

REPAIRS.....10

LIMITED WARRANTY.....11

**SAVE THESE INSTRUCTIONS**

## Introduction

84  
A

This manual has been compiled to help you to operate your craft with safety and pleasure. It contains details of the craft, the equipment supplied or fitted, its systems, and information on its operation and maintenance. Please read it carefully, and familiarize yourself with the craft before using it.

If this is your first craft, or you are changing to a type of craft you are not familiar with, for your own comfort and safety, please ensure that you obtain handling and operating experience before assuming command of the craft. Your dealer or national sailing federation or yacht club will be pleased to advise you of local sea school, or competent instructors.

PLEASE KEEP THIS MANUAL IN A SECURE PLACE, AND HAND IT OVER TO THE NEW OWNER WHEN YOU SELL THE CRAFT. RECORD THE "WATERCRAFT IDENTIFICATION NUMBER" (WIN) WHICH IS PRINTED ON THE BOAT'S HULL IN THE FOLLOWING BOX:

**WIN:** \_\_\_\_\_

## Manufacturer's Certification

Our kayaks comply with **ISO 6185** standard established by the International Organization for Standardization.

**NMMA (FOR USA ONLY)** certification means that the kayak, sold in the United States, has been judged by the National Marine Manufacture's Association to be in compliance with the U.S. Coast Guard Regulations and American Boat and Yacht Council (ABYC) standards and recommended practices.

## Safety

Craft designed for voyages on sheltered coastal waters, small bays, small lakes, rivers and canals when conditions up to, and including, wind force 4 and significant wave heights up to, and including, 0.3m may be experienced, with occasional waves of 0.5m maximum height, for example from passing vessels.



## **WARNING**

- This is not a life saving device. Use only under competent supervision. Never allow diving into this product. Never leave in or near the water when not in use. **Never tow from any vehicle.**
- Read the complete Owner's Manual before use and store this Manual in a safe place for future reference.
- Follow all the Safety and Operating Instructions on this Manual.
- TYPE III B, inflatable kayaks intended for beach use, short-time and short-distance cruising.
- **Beware of offshore winds and currents.** Never navigate alone.
- Do not exceed the maximum recommended capacities. Overloading violates regulations.
- Everyone on board must wear a Personal Floatation Device (PFD).
- Use caution when stepping or climbing aboard the kayak. Step into the center of the kayak for maximum stability.
- Distribute the weight of passengers, gear, tackle box, and accessories so that the kayak sits level fore (front) to aft (back) and side-to-side.
- Do not use your kayak if you suspect a puncture or leak.
- Adults should inflate the chambers in numbered sequence.
- Not for white water rafting or any other extreme sports activities.
- Not for commercial or rental use.
- Follow these rules to avoid drowning, paralysis or other serious injuries.

**SAVE THESE INSTRUCTIONS**



### Description

### Excursion Pro K1

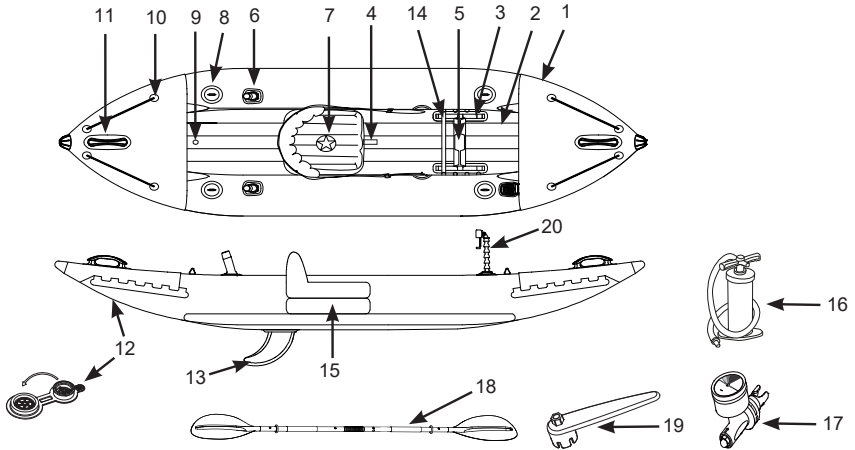

### Excursion Pro K2

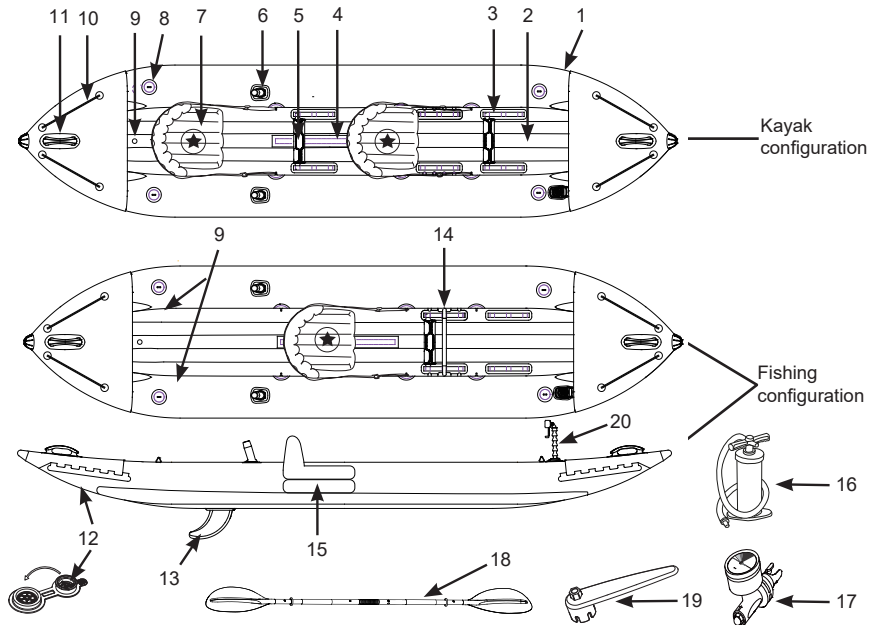

“(★)” - Recommended seating arrangement of the occupants.

**NOTE:** Drawings for illustration purpose only. Actual product may vary. Not to scale.

## SAVE THESE INSTRUCTIONS

## Description

1	Hull	2	Floor	3	Footrest belt
4	Seat velcro	5	Footrest	6	Fishing rod holder
7	Seat	8	D ring	9	Air valves
10	Safety rope	11	Grasp handle	12	Drain valve
13	Skeg	14	Fishing mounting bracket	15	Seat booster pad
16	Manual air pump	17	Pressure gauge	18	Paddle
19	Wrench	20	Accessory or smartphone mount kit		

## Skeg Installation and Removal

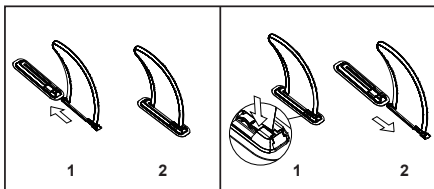

For deep water: use the large skeg. For shallow water: use the short skeg.

## GoPro or Smartphone Mount Kit Installation

1. Slide the adjustable support into the mounting base.
2. Attaching a GoPro device (not included): slide the GoPro device into the ridges on top of the adjustable support and insert the thumb screw to secure it in place. Finger tighten only.
3. Attaching the smartphone holder: slide the smartphone holder into the adjustable support ridges and insert the thumb screw to secure it in place. Finger tighten only. Extend the holder side grips outward and insert a smartphone.

**IMPORTANT:** Use only for water-proof devices. Intex is not responsible for any damage to devices used with the product.

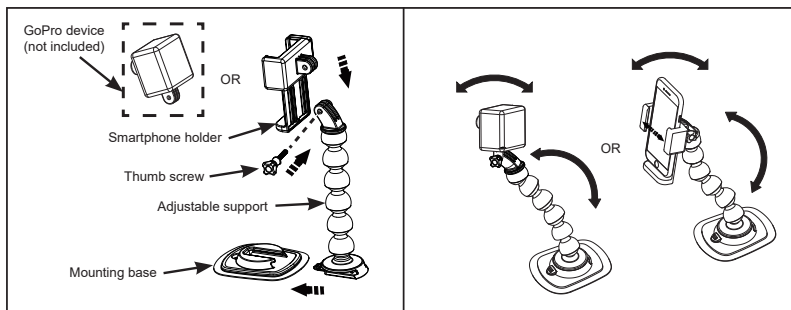

**NOTE:** Drawings for illustration purpose only. Actual product may vary. Not to scale.

# SAVE THESE INSTRUCTIONS

## Inflating Instructions

Before starting, locate a clean area free of stones or other sharp objects. Unroll the kayak so it is laid out flat, and locate your pump.

Use a hand or foot operated air pump to inflate the boat. Do not use high-pressure air compressors. Adults should inflate the chambers following the numerical sequence marked on the valves. It is very important to follow the numerical sequence; failure to do so will result in an improperly inflated boat. Fill each chamber until it is stiff to the touch but NOT hard.

Use the enclosed pressure gauge to check the main chamber for proper inflation. The pressure gauge indicator should be in the green area for a properly inflated chamber. **DO NOT OVER INFLATE.** Fill with cold air only.

**IMPORTANT:** Air temperature and weather condition do affect the internal air pressure of inflatable products. In cold weather the product will lose some pressure due to the fact that the air will contract. If this occurs, you may want to add a little air to the product. However, in hot weather, the air will expand. You must let some air out to prevent the product from failing due to overpressure.

### Air Valve Fastening

Check the air valve for leakage and tightness before use. If air is leaking from the air valve, use the provided wrench (19) to tighten the air valve as follow:

1. Make sure the product is deflated, open the air valve cap and insert the wrench (19) into the air valve body.
2. With one hand, hold the backside of the air valve base from the inside of the product and turn the wrench (19) clockwise.

**IMPORTANT:** Never adjust the air valve base when the product is in use. Only use the air valve wrench if the air valve is loose or there is leakage around air valve base. Do not over tighten the air valve: over tightening can damage the valve. Just ensure the air valve is snug and not leaking.

### Fishing Rod Holder Use

1. Slide the fishing rod holder into the mounting base.
2. Insert the end cap into the fishing rod holder.
3. Insert the fishing rod into the end cap.

### Seat Installations

1. Inflate each seat slowly to about 75% of its capacity.
2. Place the seat on the velcro stripe located on the floor according to the user size. Then hook the side strap to the D-ring on the side of the hull and adjust the strap length.
3. Finish inflating the seat slowly until it is firm to the touch but NOT hard. **DO NOT OVER INFLATE!**
4. To disassemble the seats, deflate the seats first and reverse the installation procedures.

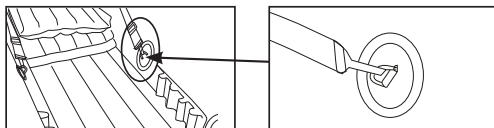

### Seat Booster Pad Installation

The seat booster pad provides an elevated seating during solo fishing configuration. Inflate the booster pad first and place it underneath the inflated seat.

### Footrest Assembly

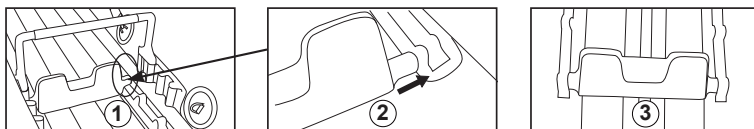

**SAVE THESE INSTRUCTIONS**

**Paddle Assembly:**

1. Press and align the push-bottom on the short shaft with the paddle blade hole, ensure the push-bottom is securely snapped onto the paddle blade hole.
2. Join the 3 shafts together with the couplers and securely tighten the coupler covers.
3. To disassemble, reverse the assembly steps. **Note:** is not necessary to detach the paddle blades from the shafts.

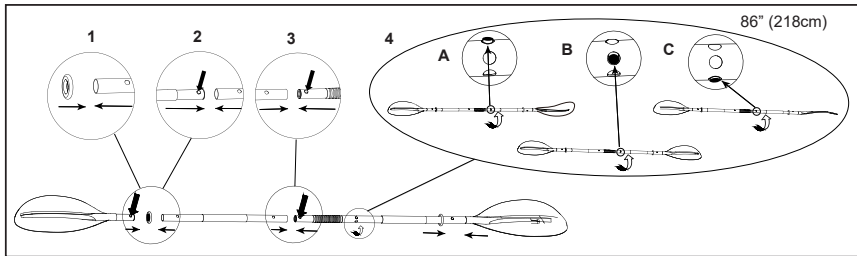
**Deflation****For kayak hull:**

1. Unscrew the cap to reveal the stem, push the stem in and turn 90 degree right to secure it in the down position.
2. Once the deflation is completed, push the stem in and turn 90 degree left to return it into the inflation position.
3. Replace the cap back.

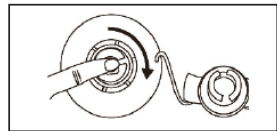
**For seat & seat booster pad:**

1. Pull valve cap out and squeeze the valve at its base until deflated.
2. Close and recess the valve back.

**Safety and Operating Instructions****Before Departing from the Shore or Dock****Know all required information and inform your passengers:**

- Take a boating safety course and get hands-on training from your boat dealer or local boating authorities.
- Know all local regulations and hazards related to water activities and boat operation.
- Check weather forecast, local currents, tides and wind conditions.
- Advise someone on land of the time you plan to be back at your starting point.
- Explain basic boat operation to all passengers.
- Children and non-swimmers need special instructions in the use of life jacket or personal flotation devices (PFD).
- Be sure that one of your passengers can operate the boat in case of emergency.
- Learn how to determine the distance you can cover, and remember that bad weather conditions can alter this.
- Review all safety requirements regularly.

**Check the working condition of the boat and equipments:**

- Check inflation pressure.
- Inspect the valves caps.
- Check the load is evenly distributed, fore (front) to aft (back) and side-to-side.

# SAVE THESE INSTRUCTIONS



**Make sure that all required safety equipment is on board (check the laws and regulations of the country or locality in which you are boating to see if additional equipment may be needed):**

- One personal flotation device (PFD) per person.
- Air pump, oars, repair kit and tool kit.
- Any other mandatory equipment.
- The boat papers and your boating license (if applicable).
- Lights are required if operating after dark.

### **Rules to Observe During Navigation**

- Be responsible, do not neglect the safety rules, this could jeopardize your life and the lives of others.
- Always keep control of your boat.
- Respect local regulations and practices.
- Near the shore, navigate in the designated boating area.
- Remember that weather conditions can rapidly deteriorate. Always be sure that you can reach a shelter rapidly.
- Everyone on board must always wear a personal flotation device (PFD).
- Do not drink alcohol or take drugs before or while operating your boat. Maintain passenger sobriety.
- Do not exceed the authorized number of persons or weight.
- Make sure your passengers remain seated at all times. At planning speeds, in rough water or during sharp turns, all passengers should position themselves in seats or on the floor.
- No bow riding. Bow riding is illegal in most areas and is extremely dangerous. In case of falling, the man overboard is in the way of the propeller.
- Be especially careful when docking. Arms and legs may be injured if they are outside the boat.
- Keep clear of swimmers and divers. Always avoid areas where divers/swimmers are in the water.
- Keep a sharp lookout especially when operating near beaches and launch sites. The Alpha flag indicates proximity of divers. You **MUST** maintain a safe distance as required by your local boating laws, which may range from 50 meters (164 feet) to 91 meters (300 feet).
- Avoid sharp turns at high speeds. You could get ejected from the boat.
- Do not make changes in direction without advising passengers.
- Avoid all contact between the buoyancy tubes and sharp objects or aggressive liquids (such as acid).
- Do not smoke on board.

### **Care and Maintenance**

The kayak is made of the highest quality materials and complies with ISO 6185 standards. Altering the construction of the kayak will endanger your own safety, safety of the occupants and void the limited warranty!

There is very little that you have to do to keep your kayak in good condition for many years. Do not store your kayak inflated. If you store it in a closet, basement or garage, we suggest you pick a cool, dry place, making sure the kayak is clean and dry before you store it - or mold can accumulate.

Use as few cleaning agents as possible, do not discharge waste agents into water, and clean your kayak preferably on land.

Clean your kayak after a trip to prevent damage from sand, salt water or sun exposure.

Most dirt can be removed with a garden hose, a sponge and mild soap. Make sure the kayak is completely dry before storing. Store the product and accessories in a dry, temperature controlled, between 32 degrees Fahrenheit (0 degrees Celsius) and 104 degrees Fahrenheit (40 degrees Celsius) storage location.

# **SAVE THESE INSTRUCTIONS**

## **Disassembly and Storage**

First clean your kayak thoroughly following the Care and Maintenance instructions. Open all air valves, deflate kayak completely and remove all the accessories from the kayak.

Flip the kayak over. Fold the left side of the kayak over and then fold the right side over the left. Fold the bow end twice to the middle of the kayak tightly while forcing out any remaining air; repeat this procedure for the stern. Replace all air valves' caps. With two opposing folded sides, fold one end over the other like closing a book. Your kayak is ready for storage. Fold the kayak loosely and avoid sharp bends, corners and creases which can damage the kayak.

## **Troubleshooting**

If your kayak appears a bit soft, it might not be because of a leak. If the kayak was inflated late in the day with 32°C (90°F) air, that air might cool down to 25°C (77°F) overnight. The cooler air exerts less pressure on the hull, so it could appear soft the next morning.

If there has been no temperature variation, you need to start looking for a leak:

- Take a good look at your kayak from just a few feet away. Flip it over and closely check over the outside. Any large leaks should be clearly visible.
- If you have an idea where your leak is, use a mix of dishwashing liquid and water in a spray bottle, and spray over the suspicious areas. Any leak will produce bubbles that will pinpoint the location of the leak.
- Check valves for leak, if necessary, spray soapy water around the valve and the valve base.

## **Repairs**

Through constant use you may occasionally puncture your kayak. Most leaks only take a few minutes to repair. Your kayak comes with a repair patch, and additional repair supplies can be ordered from Intex Consumer Service or from our website.

First locate the leak; soapy water will bubble out from the source of the leak. Thoroughly clean the area surrounding the leak to remove any dirt or grime.

Cut a piece of repair patch large enough to overlap the damaged area by approximately 1.5cm (1/2"). Round off the edges, and place the patch on the damaged area and **PRESS DOWN FIRMLY**. You may want to use a weight on top to keep it in place.

Do not inflate in 30 minutes after patching.

If the patch does not hold, you can purchase a PVC or silicon based glue for repairing camping mats, tents or shoes from your local market to patch your boat, please refer to the instruction of the glue for patching.

# **SAVE THESE INSTRUCTIONS**

## Limited Warranty Intex Inflatable Kayak

Your Intex Inflatable Kayak has been manufactured using the highest quality materials and workmanship. All Intex Inflatable kayaks have been inspected and found free of defects prior to leaving the factory. This limited warranty applies to the Intex Inflatable Kayak only.

This limited warranty is in addition to, and not a substitute for, your legal rights and remedies. To the extent that this warranty is inconsistent with any of your legal rights, they take priority. For example, consumer laws across the European Union provide statutory warranty rights in addition to the coverage you receive from this limited warranty: for information on EU-wide consumer laws, please visit the European Consumer Center website at [http://ec.europa.eu/consumers/ecc/contact\\_en/htm](http://ec.europa.eu/consumers/ecc/contact_en/htm).

The provisions of this limited warranty apply only to the original purchaser. This Limited Warranty is valid for a period of 90-days from the date of purchase. Keep your purchase information with this document, as proof of purchase will be required and must accompany warranty claims or the limited warranty will be invalid.

If you find a manufacturing defect in the Intex Inflatable Kayak during the warranty period, please contact the appropriate Intex Service Center listed in the separate "Authorized Service Centers" sheet. If the item is returned as directed by the Intex Service Center, the Service Center will inspect the item and determine the validity of the claim. If the item is covered by the provisions of the warranty, the item will be repaired or replaced, with the same or comparable item (at Intex's choice) at no charge to you.

Other than this warranty, and other legal rights in your country, no further warranties are implied. To the extent possibly in your country, in no event shall Intex be liable to you or any third party for direct or consequential damages arising out of the use of your Intex Inflatable Kayak, or Intex or its agents' and employees' actions (including the manufacture of the product). If your country does not allow the exclusion or limitation of incidental or consequential damages, this limitation or exclusion does not apply to you.

You should note that this limited warranty does not apply in the following circumstances:

- If the Intex Inflatable Kayak is subject to negligence, abnormal use or application, accident, improper operation, trailering or towing, improper maintenance or storage;
- If the Intex Inflatable Kayak is subject to damage by circumstances beyond Intex's control, including but not limited to, punctures, tears, abrasions, or ordinary wear and tear;
- To parts and components not sold by Intex; and/or
- To unauthorized alterations, repairs or disassembly to the kayak by anyone other than Intex Service Center personnel.

Read the owner's manual carefully and follow all instructions regarding proper operation and maintenance of your Intex Inflatable Kayak. Always inspect your equipment prior to use. This limited warranty will be void if use instructions are not followed.

RECORD THE OWNER'S NAME, ADDRESS, PHONE NUMBER AND **WIN** BELOW:

---



---



---



---

## SAVE THESE INSTRUCTIONS